

Bender



Bender white – *Item no. 480*



Bender black – *Item no. 490*

Design: Morten Kildahl

Year: 2008

Type: Floor lamp

Shade material: Aluminium, oil painted flexible arm in steel **Shade colour:** White matt or black matt **Base material:** Steel **Base colour:** White matt or black matt **Wire:** Black, 200 cm **Dimmer switch:** Black **Bulb:** E27 Max. 200 W **Voltage:** 220V - 240V - 50Hz **Net weight:** 4 kg **Spare part available:** Dimmer switch

Dimensions and light direction

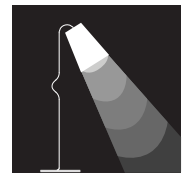
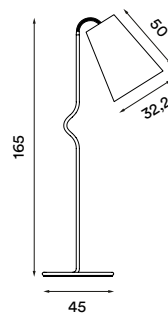

Recommended bulb (dimmable)



LED – 13 W



H – 52 W



CFL – 15 W



I – 75 W



Groggy



Groggy shade grey – *Item no. 400*



Groggy shade off-white – *Item no. 405*



Groggy base white – *Item no. 410*



Groggy base black – *Item no. 411*

Design: Tom Stepp

Year: 2009

Type: Floor lamp

Shade material: Upholstery fabrics. Type Amdal 130 from Gudbrandsdalens Uldvarefabrik in Norway

Shade colour: Grey or off-white **Body material:** Steel **Body colour:** White or matt black **Base material:** Cast iron

Base colour: White or matt black **Wire:** Grey silk, 200 cm

Bulb: E27 Max. 100 W **Voltage:** 220V - 240V - 50Hz

Net weight: 5.5 kg **Spare parts available:** Shades (grey or off-white), steel bases (white or matt black), steel base bottom cylinder (white or matt black)

Dimensions and light direction

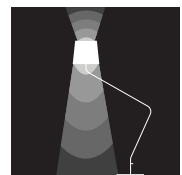
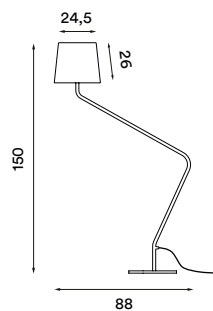

Recommended bulb



LED – 13 W



H – 52 W



CFL – 15 W



I – 75 W



Me

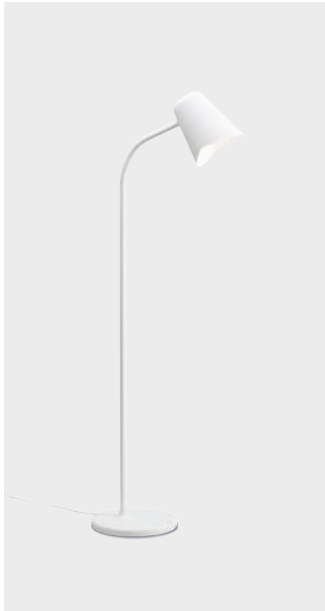

Me white – *Item no. 652*



Me grey – *Item no. 653*

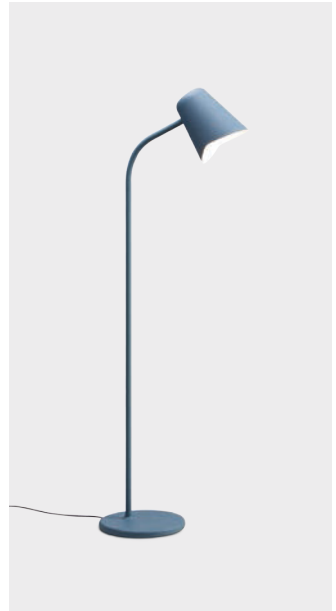

Me petrol blue – *Item no. 654*

Design: Morten & Jonas

Year: 2015

Type: Floor lamp

Shade material: Steel **Body materials:** Steel and silicone. Cast iron base **Colours:** White, petrol blue or grey **Wire:** 200 cm, black or white (on white body only) **Foot switch:** Black or white (on white body only) **Bulb:** E27 Max. 60 W 220V - 240V - 50Hz **Voltage:** 220V - 240V - 50Hz **Net weight:** 4.5 kg

Dimensions and light direction

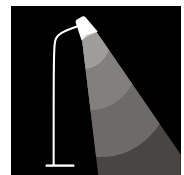
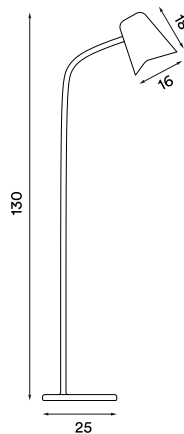

Recommended bulb



LED – 7 W



H – 40 W



CFL – 9 W



I – 60 W



Diva

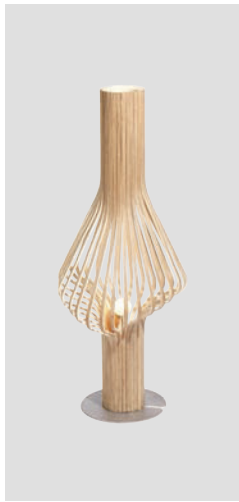

Diva floor oak
– Item no. 370



Diva floor walnut
– Item no. 371

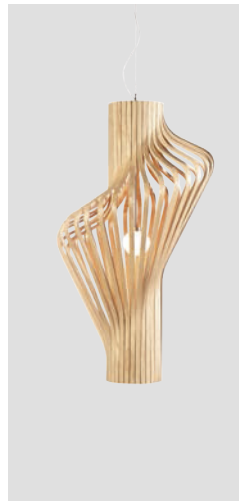

Diva pendant oak
– Item no. 380

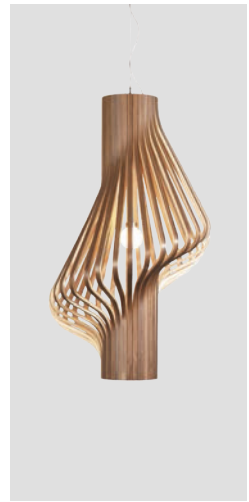

Diva pendant walnut
– Item no. 381

Design: Peter Natedal & Thomas Kalvatn Egset

Year: 2009

Types: Floor lamp and pendant lamp

Shade material: Oak or walnut wood, laminated plywood **Shade colour:** Oak or walnut **Shade material thickness:** 6.5 millimeters plywood. 1.5 millimeters oak or walnut **Shade material:** Mouth blown glass **Shade colour:** White **Base material:** Satinized nickel **Base colour:** Metallic **Wire:** Transparent. 200 cm (floor) and 250 cm (pendant) **Dimmer switch:** Transparent (floor lamp only) **Bulb:** G9 Halogen Max. 60 W **Voltage:** 220V - 240V - 50Hz **Net weight:** 7 kg (floor lamp), 4.5 kg (pendant lamp) **Spare parts available:** Dimmer switch (floor lamp), laminated plywood shade (oak or walnut), lamp base

Dimensions and light direction

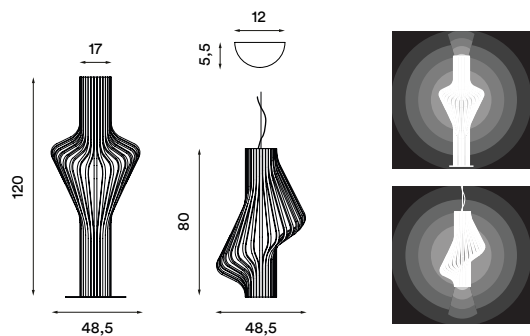

Bulb included

Energy class: C

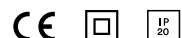

Norwegian Forest



Norwegian forest large pendant
natural birch – *Item no. 580*



Norwegian forest large pendant
white stained ash – *Item no. 581*



Norwegian forest small pendant
natural birch – *Item no. 582*



Norwegian forest small pendant
white stained ash – *Item no. 583*



Norwegian forest table natural
birch – *Item no. 584*



Norwegian forest table white
stained ash – *Item no. 585*

Design: Cathrine Kullberg

Year: 2007

Types: Pendant lamp (small and large shade)
and table lamp (small shade)

Shade material: Natural birch (double layered nordic birch veneer, 0.9 mm) or white stained ash (semi transparent white pigmented ash veneer with inner layer of white paper fleece, 0.9 mm, leather lace **Shade colour:** Natural (birch) or white stained (ash) **Body material:** Steel **Body colour:** White **Wire:** White 350 cm (pendant lamps). White 150 cm with string pull switch (table lamp) **Bulb:** E27 Max. 60 W **Voltage:** 220V - 240V ~ 50Hz **Net weight:** Large pendant 1.2 kg, small pendant 0.9 kg, table lamp 0.9 kg

Dimensions and light direction

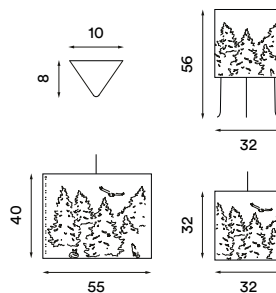

Recommended bulb

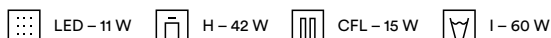

Oslo Wood



Oslo Wood beige shade – *Item no. 160*
Oslo Wood steel feet – *Item no. 180*

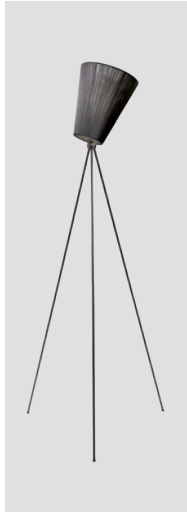

Oslo Wood black shade – *Item no. 161*
Oslo Wood black feet – *Item no. 181*



Oslo Wood light blue shade – *Item no. 162*
Oslo Wood white feet – *Item no. 182*



Oslo Wood green shade – *Item no. 163*
Oslo Wood glossy black feet – *Item no. 183*



Oslo Wood green shade – *Item no. 163*
Oslo Wood gold feet – *Item no. 184*

Design: Ove Rogne

Year: 2006

Type: Floor lamp

Dimensions and light direction

Shade material: Coloured chain link fabric

Shade colour: Beige, black, green or light blue

Body material: Steel **Body colour:** Metallic, black, glossy black, gold or white **Wire:** Black or white (on white body only, 200 cm **Dimmer switch:** Black or white (on white body only)

Bulb: E27 Max. 100 W **Voltage:** 220V 240V ~

50Hz **Net weight:** 3.45 kg **Spare parts available:**

Dimmer switch, shades (beige, black, green or light blue), body bases (metallic, black, glossy black, gold or white), shade fastening ring

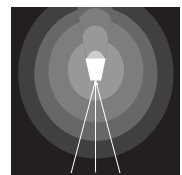
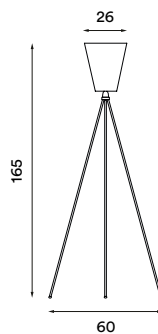

Recommended bulb

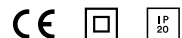

Illusion



Illusion white – *Item no. 440*



Illusion black – *Item no. 441*



Illusion half white – *Item no. 442*



Illusion half black – *Item no. 443*

Design: Hareide Design

Year: 2010

Types: Pendant lamp and wall lamp

Dimensions and light direction

Shade material: Aluminium **Body material:** Steel
Base material (pendant lamp only): Steel
Shade colour: White shiny or black matt **Body colour:** White shiny or black matt **Base colour (pendant lamp only):** Black matt **Wire (pendant lamp only):** White or black silk, 350 cm **Bulbs pendant lamp:** GU10 Max. 50W x 4 **Bulbs wall lamp:** GU10 Max. 50W x 2 **Voltage:** 220V - 240V - 50Hz **Net weight pendant lamp:** 5.1 kg (plus floor base) **Net weight wall lamp:** 2.6 kg **Spare parts available:** Steel floor base (pendant), base/floor connection screw (pendant)

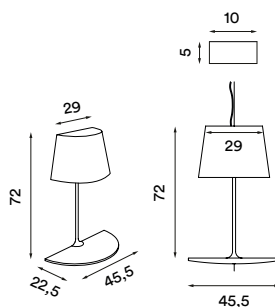

Recommended bulbs



LED – 4 W



H – 20 W



Big Mama



Big Mama base – *Item no. 350* / Big Mama shade – *Item no. 360*

Design: Estela+Nereo

Year: 2009

Type: Floor lamp

Shade material: Parchment paper

Shade colour: White **Body material:**

Weed tree wood **Body colour:** White

Wire: White, 180 cm **Dimmer switch:**

White **Bulb:** E27 Max. 3 x 100W **Voltage:**

220V - 240V - 50Hz **Net weight:** 17 kg

Spare part available: Dimmer switch

Dimensions and light direction

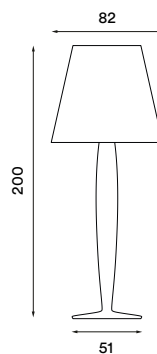

Recommended bulbs (dimmable)



LED – 9 W



H – 42 W



CFL – 11 W



I – 60 W



Snowball

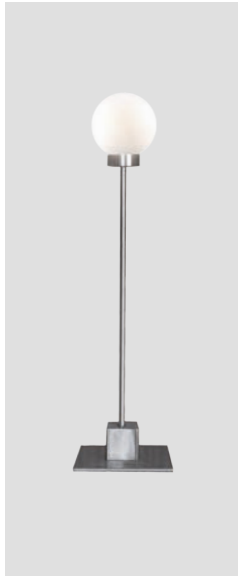

Snowball metallic small
– Item no. 120

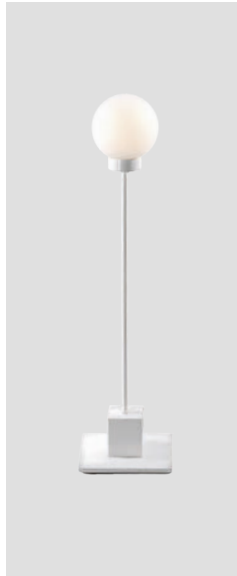

Snowball white small
– Item no. 121

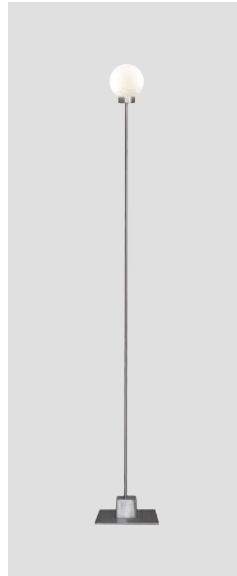

Snowball metallic large
– Item no. 122

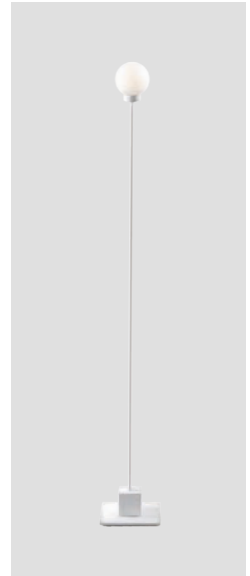

Snowball white large
– Item no. 123

Design: Trond Svendgård
Year: 2005
Types: Table and floor lamp

Dimensions and light direction

Shade material: Mouth blown glass
Shade colour: White glass **Body material:** Steel and aluminium **Body colour:** Metallic or white **Wire:** Transparent, 200 cm (floor) or 170 cm (table) **Dimmer switch:** Transparent
Bulb: G9 Halogen Max. 40 W **Voltage:** 220V - 240V - 50Hz **Net weight:** 1.24 kg (table), 2.55 kg (floor) **Spare part available:** Glass shade

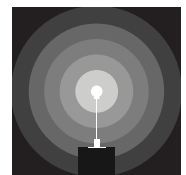
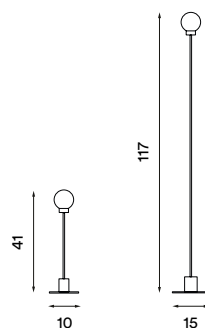

Bulb included

Energy class: C



Birdy



Birdy table black
– Item no. 600

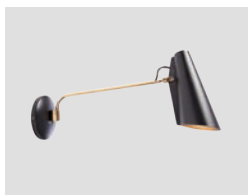

Birdy wall black
– Item no. 610



Birdy wall short black
arm black – Item no. 615



Birdy floor black
– Item no. 620



Birdy table white
– Item no. 601



Birdy wall white
– Item no. 611



Birdy wall short white
arm white – Item no. 616



Birdy floor white
– Item no. 621



Birdy table grey
– Item no. 602



Birdy wall grey
– Item no. 612



Birdy wall short grey
– Item no. 617



Birdy floor grey
– Item no. 622

Design: Birger Dahl

Year: 1952

Types: Table lamp, wall lamp
and floor reading lamp

Shade material: Aluminium **Shade colours:**
Off-white (white inside), grey (grey inside) or
matt black (black inside) **Body material:** Steel
Body colour: Metallic or brass finish **Base and
handle colours:** Off-white, grey or matt black
Body and joints colour: Metallic or brass
finish **Wire:** White or black, 200 cm **Bulb:** E27
Max. 60 W **Voltage:** 220V - 240V - 50Hz **Net
weight:** Birdy wall short: 0.7 kg, Birdy wall: 0.8
kg, Birdy table: 1.9 kg, Birdy floor: 5.0 kg

Dimensions and light direction

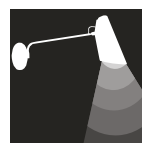
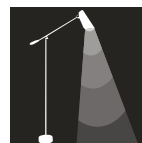
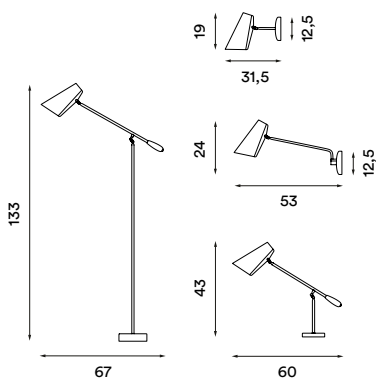

Recommended bulb



LED – 7 W



H – 40 W



CFL – 11 W



I – 60 W

