

Pablo®

UMA
MINI

SETUP GUIDE & OWNERS MANUAL

PABLO DESIGNS
888 MARIN STREET
SAN FRANCISCO, CA
94124

PABLODESIGNS.COM
UMA SUPPORT: 888-355-0636
UMASUPPORT@PABLODESIGNS.COM



Pablo®

UMA MINI

UMA MINI INDICATOR OVERVIEW

INDICATOR LIGHT FUNCTIONS:

POWER INDICATOR LIGHT	ILLUMINATED WHITE	POWER IS ON / BATTERY CHARGE 10%-90%
	BREATHING GREEN	POWER IS ON / BATTERY CHARGE 90%-99%
	ILLUMINATED GREEN	POWER IS ON / BATTERY CHARGE 100%
	BREATHING RED	POWER IS ON / BATTERY CHARGE LOW
	UNLIT	POWER IS OFF
	BREATHING BLUE	BLUETOOTH PAIRING MODE ACTIVATED
	ILLUMINATED BLUE	UNIT IS IN PARTY HOST MODE

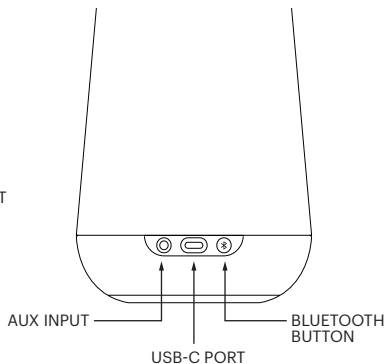
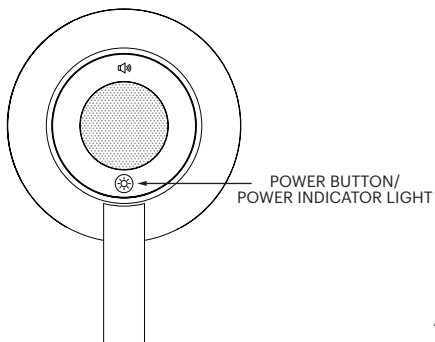

Pablo®

UMA MINI

CHARGING UMA MINI

UMA MINI USES AN INTERNAL RECHARGEABLE LITHIUM POLYMER BATTERY THAT WILL LAST THE LIFETIME OF THE DEVICE. FULLY CHARGE UMA MINI'S BATTERY PRIOR TO FIRST USE. TO CHARGE THE BATTERY, CONNECT THE INCLUDED USB-C CABLE TO UMA MINI THEN TO A POWER SUPPLY (NOT PROVIDED)

ANY USB CHARGER WILL WORK WITH UMA MINI. WE RECOMMEND A 10-WATT (5V / 2.1A) USB CHARGER.

KEEP UMA MINI CONNECTED TO THE POWER SOURCE UNTIL POWER INDICATOR LIGHT TURNS SOLID GREEN TO INDICATE A FULL CHARGE. IT MAY TAKE UP TO 2.5 HOURS (FROM ZERO) TO FULLY CHARGE UMA MINI WITH A 10-WATT CHARGER.

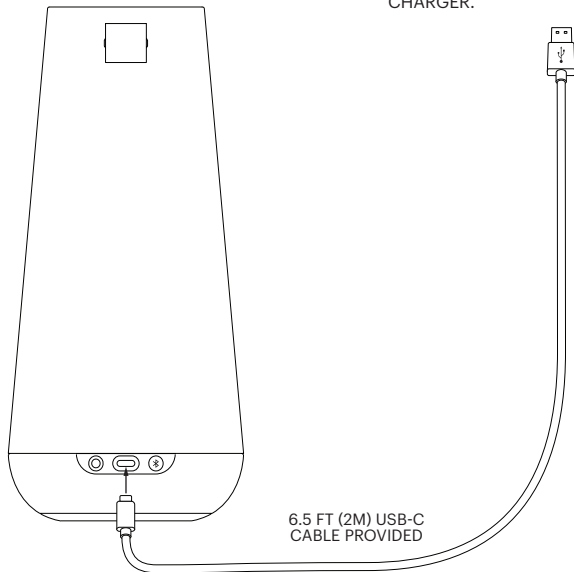

6.5 FT (2M) USB-C
CABLE PROVIDED

Pablo®

UMA MINI

UMA MINI LIGHT FUNCTION

TO TURN UMA MINI ON, PRESS & HOLD POWER BUTTON FOR 2 SECONDS. POWER INDICATOR LIGHT WILL ILLUMINATE, AND LIGHT WILL TURN ON AT HIGH BRIGHTNESS.

PRESS POWER BUTTON AGAIN BUT BRIEFLY TO CYCLE THROUGH HIGH LIGHT, LOW LIGHT, AND LIGHT OFF.

TO TURN POWER OFF, PRESS & HOLD POWER BUTTON FOR 2 SECONDS.

CONTROLS

- PRESS & HOLD FOR POWER ON.
- PRESS BRIEFLY TO CYCLE LIGHT INTENSITY.
- PRESS & HOLD TO POWER OFF.

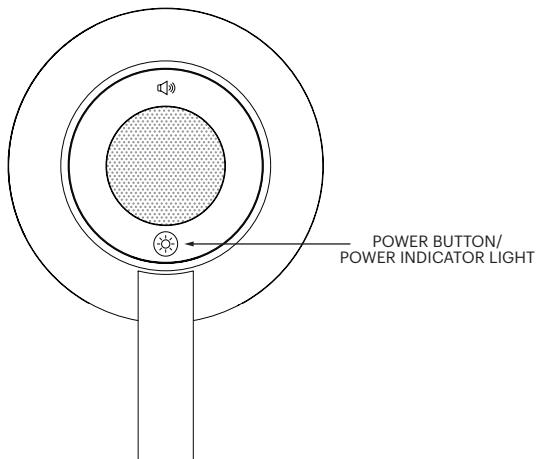

NOTE:

UMA MINI WILL TURN OFF AUTOMATICALLY AFTER 15 MINS OF INACTIVITY.
(INACTIVITY = LIGHT IS OFF & NO SOUND IS PLAYING)

Pablo®

UMA MINI

UMA MINI SOUND FUNCTION

VOLUME IS CONTROLLED THROUGH A TOUCH CAPACITIVE PAD ON THE TOP OF UMA MINI. USING YOUR FINGER, SLIDE CLOCKWISE TO TURN VOLUME UP, SLIDE COUNTER CLOCKWISE TO TURN VOLUME DOWN.

NOTE: MAKE SURE THE CONNECTED DEVICE'S VOLUME IS TURNED UP.

CONTROLS

- TOUCH INTERFACE.
- REQUIRES 540 DEGREES OF TOUCH ROTATION TO TRAVEL FROM 0%-100% VOLUME.
- SLIDE FINGER CLOCKWISE TO INCREASE VOLUME.
- SLIDE FINGER COUNTER CLOCKWISE TO DECREASE VOLUME.
- VOLUME IS CONTROLLED BY DIRECTION AND DISTANCE OF SLIDE REGARDLESS OF POSITION.

VOLUME DOWN
COUNTER CLOCKWISE

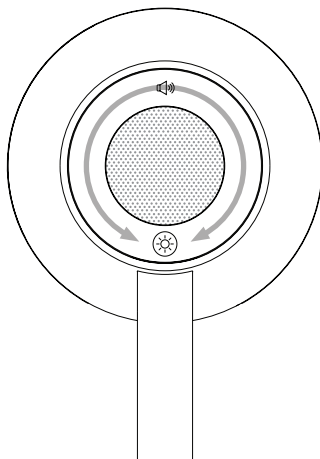

VOLUME UP
CLOCKWISE

NOTE:

UMA MINI WILL TURN OFF AUTOMATICALLY AFTER 15 MINS OF INACTIVITY.
(INACTIVITY = LIGHT IS OFF & NO SOUND IS PLAYING)

Pablo®

UMA MINI

CONNECTING UMA MINI TO A BLUETOOTH® WIRELESS TECHNOLOGY ENABLED DEVICE

PAIRING:

WHEN CONNECTING A BLUETOOTH DEVICE TO UMA MINI FOR THE FIRST TIME, THE DEVICE MUST BE REGISTERED WITH UMA MINI. THIS IS CALLED PAIRING. ONCE PAIRING IS COMPLETED, UMA MINI WILL REMEMBER YOUR DEVICE AND CONNECT AUTOMATICALLY. UMA MINI CAN REMEMBER UP TO 8 DEVICES. TO PAIR YOUR DEVICE WITH UMA MINI, FOLLOW THESE STEPS:

1. PRESS & HOLD POWER SWITCH TO TURN UMA MINI ON. POWER INDICATOR LIGHT WILL ILLUMINATE.
2. PRESS & HOLD THE BLUETOOTH PAIRING BUTTON ON UMA MINI FOR 1.5 SECONDS TO PUT UMA MINI INTO PAIRING MODE, INDICATED BY A BREATHING BLUE LIGHT. UMA MINI WILL REMAIN IN PAIRING MODE UNTIL A CONNECTION IS MADE, OR FOR UP TO ONE MINUTE.
3. TURN ON THE BLUETOOTH FUNCTION ON YOUR DEVICE.
4. IN THE BLUETOOTH SETTINGS OF THE DEVICE, SELECT "UMA MINI" FROM THE LIST OF AVAILABLE CONNECTIONS.
5. INDICATOR LIGHT ON UMA MINI WILL CHANGE TO WHITE WHEN THE CONNECTION IS SUCCESSFUL.
6. PLAY MUSIC ON YOUR DEVICE. ENSURE VOLUME ON YOUR DEVICE IS NOT SET TO MUTE.
7. AFTER YOUR DEVICE HAS PAIRED WITH UMA MINI, IT WILL CONNECT AUTOMATICALLY TO THE MOST RECENTLY CONNECTED DEVICE. IF IT DOES NOT CONNECT AUTOMATICALLY, REPEAT THE PAIRING PROCESS TO REGISTER YOUR DEVICE.

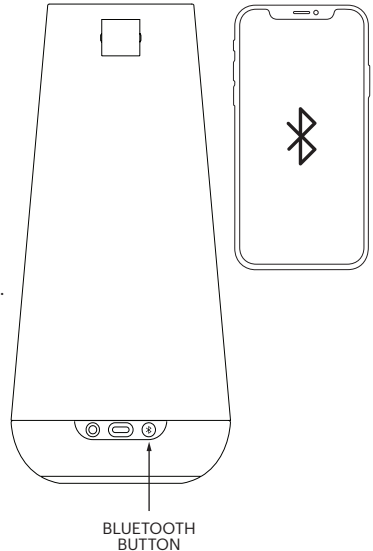

IF YOU HAVE DIFFICULTY CONNECTING TO UMA MINI, PLEASE REFER TO THE TROUBLESHOOTING GUIDE IN THIS INSTRUCTION MANUAL.

Pablo®

UMA MINI

CONNECTING UMA MINI TO A DEVICE VIA PROVIDED AUXILIARY CABLE

UMA MINI CAN PLAY MUSIC FROM AN AUDIO DEVICE BY CONNECTING THE AUX-IN CABLE (NOT PROVIDED). TO CONNECT YOUR DEVICE TO UMA MINI WITH AUXILIARY CABLE, FOLLOW THESE STEPS:

1. PRESS POWER SWITCH FOR 2 SECONDS TO TURN UMA MINI ON. POWER INDICATOR LIGHT WILL ILLUMINATE.
2. PLUG AUXILIARY CABLE INTO UMA MINI'S AUDIO-IN PORT. BLUETOOTH WIRELESS TECHNOLOGY WILL BE DISABLED AND ALL WIRELESS CONNECTIONS WILL BE DISCONNECTED, EXCEPT FOR PARTY MODE CONNECTIONS.
3. PLUG THE OTHER END OF THE AUXILIARY CABLE INTO THE AUDIO-OUT (HEADPHONE) PORT ON YOUR DEVICE.
4. PLAY MUSIC ON YOUR DEVICE. ENSURE VOLUME ON YOUR DEVICE IS NOT MUTED.

NOTE: AUXILIARY CABLE IS NON-DIRECTIONAL.

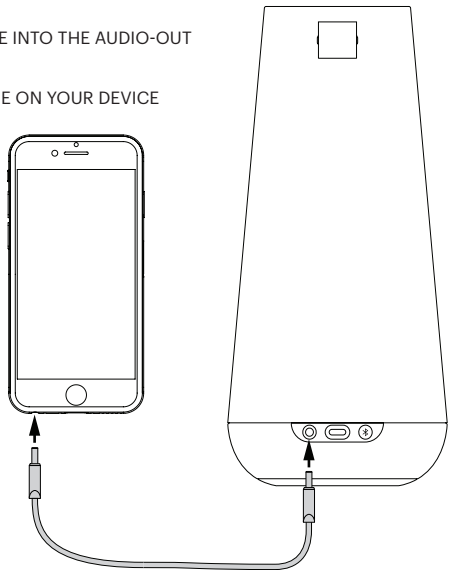

Pablo®

UMA MINI

PARTY MODE ON UMA MINI

“PARTY MODE” REFERS TO CONNECTING MORE THAN ONE UMA MINI TO A SINGLE PHONE (OR OTHER SOURCE OF MUSIC/SOUND)

PARTY MODE **HOST**: IS THE FIRST UMA MINI THAT CONNECTS TO THE PHONE (OR OTHER SOURCE OF MUSIC/SOUND). THE HOST STREAMS MUSIC TO ALL CONNECTED SATELLITES.

PARTY MODE **SATELLITES**: ARE THE ADDITIONAL UNITS THAT CONNECT TO THE HOST. THE SATELLITES DO NOT CONNECT DIRECTLY TO THE PHONE WHEN IN PARTY MODE. EACH OF THE SATELLITES CONNECTS TO THE HOST, LIKE SPOKES TO A HUB. THIS IS AN IMPORTANT CONSIDERATION FOR RANGE AND FOR HOW THE CONNECTIONS ARE MADE. THE VOLUME ON SATELLITES CANNOT BE INDIVIDUALLY CONTROLLED WHILE IN PARTY MODE; VOLUME CAN ONLY BE CONTROLLED BY THE HOST OR THE PHONE.

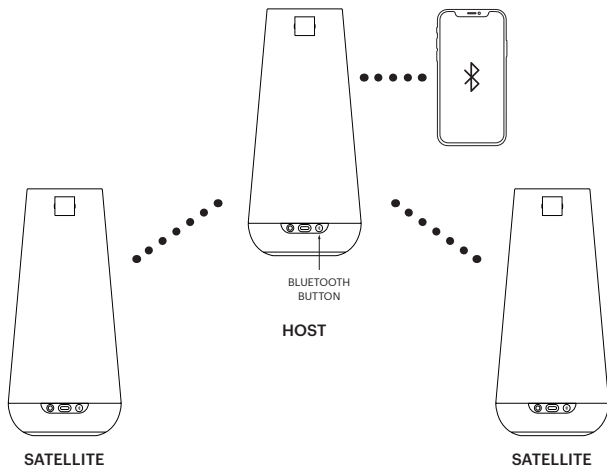

NOTE: THE HOST CAN BE CONNECTED TO THE PHONE (OR OTHER SOURCE OF MUSIC/SOUND) VIA BLUETOOTH OR AUX CABLE.

Pablo®

UMA MINI

SETTING UP PARTY MODE ON UMA MINI

THIS FEATURE REQUIRES MORE THAN ONE UMA MINI. YOU CAN CONNECT THE HOST UP TO 23 SATELLITE UMA MINIS FOR PARTY MODE.

1. CONNECT ONE UMA MINI TO A PHONE (OR OTHER SOURCE OF MUSIC/SOUND) VIA BLUETOOTH OR AUX CABLE. REFER TO PAGES 5 & 6 FOR STEPS. THIS UMA MINI WILL BE THE HOST.
2. ON THE SAME UMA MINI (THE HOST), PRESS & HOLD BLUETOOTH BUTTON FOR 5 SECONDS TO ACTIVATE PARTY MODE HOST. DISREGARD THE PAIRING TONE AFTER 1.5 SECONDS AND CONTINUE HOLDING THE BLUETOOTH BUTTON UNTIL HEARING "PARTY MODE HOST." THE UNIT IS NOW SEARCHING FOR A SATELLITE AND WILL STOP AFTER 1 MINUTE IF NO CONNECTION IS MADE.
3. ON A DIFFERENT UMA MINI, QUICKLY DOUBLE PRESS THE BLUETOOTH BUTTON TO ACTIVATE PARTY MODE SATELLITE. THE UNIT SHOULD SAY "PARTY MODE SATELLITE" AFTER PRESSING THE BUTTON AND IS NOW SEARCHING FOR THE HOST AND WILL STOP AFTER 1 MINUTE IF NO CONNECTION IS MADE.
4. WHILE BOTH UNITS ARE SEARCHING, SHORT PRESS THE BLUETOOTH BUTTON ON EACH UNIT TO COMPLETE THE CONNECTION. BOTH UNITS WILL MAKE A SOUND INDICATING THEY ARE CONNECTED. **NOTE: THIS STEP IS ONLY NECESSARY AT INITIAL SETUP, NOT EVERY TIME THE UNITS CONNECT.** THE INDICATOR LIGHT ON THE HOST WILL TURN SOLID BLUE, AND REMAIN BLUE THE ENTIRE TIME THE UNIT IS IN HOST MODE. THE INDICATOR LIGHT ON THE SATELLITE WILL TURN SOLID BLUE FOR 1 MINUTE AFTER STARTUP, THEN RETURN TO NORMAL WHITE COLOR.
5. TO CONNECT MORE UMA MINI SATELLITES, PERFORM THE SAME STEPS ABOVE WITH EACH ADDITIONAL SATELLITE AND THE SAME UMA MINI HOST. YOU CAN CONNECT THE HOST UP TO 23 SATELLITE UMA MINIS FOR PARTY MODE.
6. ONCE THE HOST AND SATELLITES HAVE MADE A CONNECTION, THEY WILL REMEMBER EACH OTHER AND AUTOMATICALLY CONNECT EVERY TIME.

NOTE: THE VOLUME ON SATELLITES CANNOT BE INDIVIDUALLY CONTROLLED WHILE IN PARTY MODE; VOLUME CAN ONLY BE CONTROLLED BY THE HOST OR THE PHONE.

Pablo®

UMA MINI

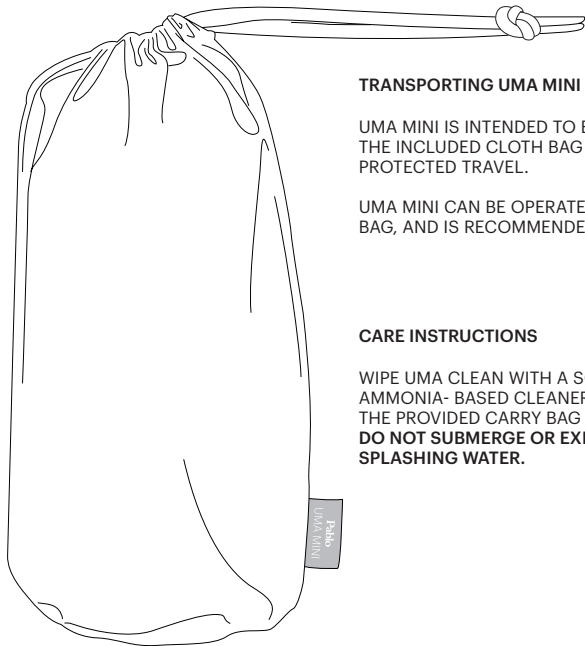

TRANSPORTING UMA MINI

UMA MINI IS INTENDED TO BE TRANSPORTED IN THE INCLUDED CLOTH BAG FOR CONVENIENT AND PROTECTED TRAVEL.

UMA MINI CAN BE OPERATED WHILE IN THE TRAVEL BAG, AND IS RECOMMENDED IN DAMP CONDITIONS.

CARE INSTRUCTIONS

WIPE UMA CLEAN WITH A SOFT DAMP CLOTH. AVOID AMMONIA- BASED CLEANERS. PROTECT UMA WITH THE PROVIDED CARRY BAG WHEN TRANSPORTING. **DO NOT SUBMERGE OR EXPOSE TO RAINFALL OR SPLASHING WATER.**



UMA MINI

BLUETOOTH® WIRELESS TECHNOLOGY CONNECTION TROUBLESHOOTING GUIDE

IF YOU HAVE DIFFICULTY CONNECTING YOUR DEVICE TO UMA MINI, FOLLOW THIS GUIDE:

PROBLEM	CAUSE	SOLUTION
UMA MINI CANNOT MAKE A BLUETOOTH CONNECTION	UMA MINI IS TURNED OFF	PRESS POWER SWITCH 2 SEC. TO TURN UMA MINI ON. POWER INDICATOR LIGHT WILL ILLUMINATE.
	BLUETOOTH FUNCTION IS TURNED OFF	PRESS THE BLUETOOTH BUTTON TO ENABLE BLUETOOTH FUNCTION.
	UMA MINI HAS NOT YET BEEN PAIRED WITH THE BLUETOOTH DEVICE	PERFORM PAIRING PROCESS (P.5).
	UMA MINI IS TOO FAR FROM THE BLUETOOTH DEVICE	MOVE THE AUDIO SOURCE CLOSER. MAXIMUM DISTANCE FROM DEVICE IS 30M (98 ft) UNOBSTRUCTED.
	AN AUX-IN CABLE IS CONNECTED	DISCONNECT AUX-IN CABLE.
	ANOTHER BLUETOOTH DEVICE IS CONNECTED	DISCONNECT OR POWER OFF THE OTHER BLUETOOTH DEVICE.
	THE PAIRING INFORMATION HAS BEEN DELETED. UMA MINI CAN REMEMBER UP TO 8 DEVICE PAIRINGS. IF A 9TH DEVICE IS PAIRED, UMA MINI WILL FORGET THE FIRST DEVICE	PERFORM PAIRING PROCESS AGAIN (P.5).
	UMA MINI IS NOT REGISTERED ON THE DEVICE'S BLUETOOTH CONNECTION LIST	PERFORM PAIRING PROCESS AGAIN (P.5).
	THERE IS A DEVICE (MICROWAVE, WIRELESS LAN, ETC.) THAT OUTPUTS SIGNALS IN THE 2.4 GHz FREQUENCY BAND NEARBY	MOVE UMA MINI AWAY FROM ANY DEVICE THAT EMITS RF SIGNALS OR INTERFERENCE.

UMA MINI

LIGHT AND AUDIO FUNCTION TROUBLESHOOTING GUIDE

IF YOU HAVE DIFFICULTY PROPERLY OPERATING UMA MINI, FOLLOW THIS GUIDE

PROBLEM	CAUSE	SOLUTION
BLUETOOTH AUDIO CONNECTION IS DISTORTED OR DROPPING OUT	THE SOURCE DEVICE IS TOO FAR AWAY FROM UMA	MOVE THE AUDIO SOURCE CLOSER. MAXIMUM DISTANCE FROM DEVICE IS 30M (98 FT) UNOBSTRUCTED.
	THERE IS A DEVICE (MICROWAVE, WIRELESS LAN, ETC.) THAT OUTPUTS SIGNALS IN THE 2.4 GHz FREQUENCY BAND NEARBY	MOVE UMA MINI AWAY FROM ANY DEVICE THAT EMITS RF SIGNALS OR INTERFERENCE.
	THE VOLUME ON EITHER THE AUDIO SOURCE OR UMA MINI IS TOO LOW	ADJUST THE VOLUME ON BOTH UMA MINI AND THE AUDIO SOURCE.
	POOR CONNECTION BETWEEN UMA MINI AND THE SOURCE DEVICE	RESTART BOTH THE AUDIO SOURCE AND UMA MINI.
	BLUETOOTH PAIRING FAILED	RE-PAIR YOUR DEVICE WITH UMA MINI.
	SOURCE DEVICE IS PAIRED TO A DIFFERENT BLUETOOTH DEVICE	DISCONNECT OR POWER OFF THE OTHER BLUETOOTH DEVICE.
3.5MM AUXILIARY AUDIO CONNECTION IS DISTORTED OR DROPPING OUT	3.5MM AUXILIARY CABLE IS NOT FULLY CONNECTED TO EITHER UMA MINI OR THE SOURCE DEVICE	CHECK THAT THE 3.5MM AUXILIARY CABLE IS SECURELY CONNECTED TO BOTH UMA MINI AND THE SOURCE DEVICE.
	SOURCE DEVICE ISN'T WORKING PROPERLY	TRY DIFFERENT SOURCE DEVICE TO ENSURE THE ISSUE ISN'T THE SOURCE DEVICE.
	3.5MM AUXILIARY CABLE IS FAULTY OR DAMAGED	TRY A DIFFERENT 3.5MM AUXILIARY CABLE.
STREAMED AUDIO CONTENT IS DISTORTED OR DROPPING OUT	INTERNET CONNECTIVITY ISSUES	FOLLOW YOUR ROUTER/ISP INSTRUCTIONS TO ENSURE YOUR INTERNET CONNECTION IS FUNCTIONING PROPERLY.

IF PROBLEMS PERSIST, PLEASE CONTACT UMA SUPPORT: 888-355-0636 / UMASUPPORT@PABLODESIGNS.COM



UMA MINI

PARTY MODE TROUBLESHOOTING GUIDE

IF YOU HAVE DIFFICULTY PERFORMING PARTY MODE, FOLLOW THIS GUIDE:

PROBLEM	CAUSE	SOLUTION
UMA MINI IS NOT ACTIVATING PARTY MODE HOST	UNIT IS POWERED OFF	MAKE SURE UMA MINI IS CHARGED AND IS POWERED ON.
	BLUETOOTH BUTTON WAS NOT PRESSED & HELD FOR 5 SECONDS	PRESS & HOLD BLUETOOTH BUTTON FOR 5 SECONDS TO ACTIVATE PARTY MODE HOST. CONTINUE HOLDING THE BLUETOOTH BUTTON UNTIL HEARING "PARTY MODE HOST."
UMA MINI IS NOT ACTIVATING PARTY MODE SATELLITE	UNIT IS POWERED OFF	MAKE SURE UMA MINI IS CHARGED AND IS POWERED ON.
	BLUETOOTH BUTTON WAS NOT QUICKLY DOUBLE PRESSED	THE UNIT SHOULD SAY "PARTY MODE SATELLITE" AFTER DOUBLE PRESSING THE BLUETOOTH BUTTON.
UMA MINI IS ONLY PLAYING MUSIC ON ONE DEVICE	BLUETOOTH BUTTON WAS NOT PRESSED ONCE ON EACH UNIT AFTER ACTIVATING PARTY MODE HOST & PARTY MODE SATELLITE	MAKE SURE TO SHORT PRESS THE BLUETOOTH BUTTON ON EACH UMA MINI UNIT AFTER ACTIVATING PARTY MODE HOST & PARTY MODE SATELLITE TO COMPLETE THE CONNECTION.
	PARTY MODE HAS NOT BEEN SET UP	REFER TO PAGES 8-9 TO SET UP PARTY MODE.
WHICH ONE IS THE HOST?	CAN'T IDENTIFY HOST	THE UMA MINI HOST WILL HAVE A SOLID BLUE INDICATOR LIGHT WHEN POWERED ON.
DON'T HAVE THE UMA MINI HOST ANYMORE	THE UMA MINI HOST IS LOST/ NOT WORKING	PERFORM A FACTORY RESET FOR ALL UMA MINI'S AND ESTABLISH ANOTHER UNIT AS THE HOST.
UNABLE TO CHANGE UMA MINI PARTY MODE HOST	THERE IS ANOTHER HOST	PERFORM A FACTORY RESET. NOTE THAT THIS WILL DELETE ALL STORED CONNECTIONS.
SATELLITES' CONNECTIONS ARE CUTTING OFF	UMA MINI SATELLITES ARE TOO FAR FROM THE HOST	MOVE THEM CLOSER. MAXIMUM DISTANCE FROM HOST IS 30M (98 ft) UNOBSTRUCTED.
CAN'T CONTROL VOLUME	ADJUSTING VOLUME FROM SATELLITE	VOLUME CAN ONLY BE CONTROLLED FROM HOST OR PHONE WHEN IN PARTY MODE.

Pablo®

UMA MINI

PERFORMING FACTORY RESET ON UMA MINI

YOU CAN PERFORM A FACTORY RESET ON UMA MINI IF NEEDED. THIS WILL DELETE ALL PAIRED BLUETOOTH DEVICES AND PARTY MODE CONNECTIONS.

1. TURN UMA MINI ON BY PRESSING & HOLDING THE POWER BUTTON FOR 2 SECONDS.
2. PRESS & HOLD THE BLUETOOTH BUTTON FOR **10 SECONDS**. DISREGARD THE PAIRING TONE AND "PARTY MODE HOST."
3. RELEASE THE BUTTON AFTER HEARING "FACTORY RESET."
4. WAIT APPROXIMATELY 1 MINUTE AFTER RESETTING UMA MINI BEFORE RESTARTING IT.
5. UMA MINI IS NOW RESTORED TO FACTORY SETTINGS AND READY FOR NEW CONNECTIONS.

Pablo®

UMA MINI

MORE INFO

FOR MORE INFORMATION AND PRODUCT DETAILS VISIT WWW.PABLODESIGNS.COM

SPECIFICATIONS

LIGHT OUTPUT:	100 LUMENS MAX
BATTERY RUNTIME:	UP TO 20 HOURS DEPENDING ON USE
CHARGE TIME:	UP TO 3 HOURS
POWER CONSUMPTION:	4W (LIGHT) 8W MAX (SPEAKERS)
SPEAKER WATTAGE:	8W MAX
BLUETOOTH VERSION:	5.0
BLUETOOTH RANGE:	30M
DIMENSIONS:	8.4" X 4" X 5.6" (21.4CM X 10CM X 14.2CM)
WEIGHT:	1.54LBS (0.7KGS)

PATENT PENDING

MADE IN CHINA

WARRANTY

FOR WARRANTY AND ADDITIONAL TROUBLESHOOTING INFORMATION VISIT

WWW.PABLODESIGNS.COM/PRODUCT/UMA-MINI

FOLLOW US

FOLLOW US ON FACEBOOK AND INSTAGRAM

WWW.FACEBOOK.COM/PABLODESIGNSSF

[@PABLODESIGNSSF](https://www.instagram.com/pablodesignssf)

Pablo